

A photograph of three children jumping joyfully in a park. The child in the foreground is wearing a red and white baseball-style shirt and white shorts, with their arms outstretched and a wide smile. Behind them, another child in a colorful striped shirt is also jumping, and a third child in a white shirt is visible in the background. The scene is set in a lush green park with trees and a clear sky.

 **OUTFIT**  
**Junior**

**KIDS  
OUTDOOR GYM  
EQUIPMENT**

**UNLOCK THE POWER OF PLAY AND FITNESS!**

**IRELAND'S OUTDOOR FITNESS EXPERTS**

# EMPOWERING KIDS THROUGH OUTDOOR FITNESS

## INVEST IN THEIR HEALTH, INVEST IN THEIR FUTURE!

At OUTFIT we believe in fostering a lifelong love for fitness and well-being from an early age. It is well established how important it is to get kids involved in physical activity in early life, and the lifelong benefits that are provided by forming those habits early.

Our innovative range of kids outdoor gym equipment is designed to inspire children to embrace exercise in a fun and engaging way.

Kids can build strength, improve coordination, and enhance their overall physical fitness, while enjoying the outdoors.

# THE BENEFITS OF A KIDS OUTDOOR GYM

## PHYSICAL HEALTH MADE FUN

- ▲ Develop strength, endurance, and cardiovascular fitness
- ▲ Enhance fine and gross motor skills and coordination
- ▲ Build strong bones and muscles
- ▲ Enhance flexibility and agility
- ▲ Reduce the risk of weight-related health issues

## MENTAL WELL-BEING AND COGNITIVE DEVELOPMENT

- ▲ Increase focus, concentration, and attention span
- ▲ Boost mood and reduce stress levels
- ▲ Enhance self-confidence and self-esteem
- ▲ Stimulate brain function and cognitive skills
- ▲ Improve social interaction and teamwork

## ENCOURAGING HEALTHY HABITS FROM AN EARLY AGE

- ▲ Instil a positive attitude towards physical activity
- ▲ Establish lifelong habits of exercise and fitness
- ▲ Foster a sense of responsibility for personal well-being
- ▲ Encourage outdoor play and exploration
- ▲ Develop a lifelong love for a healthy lifestyle





## EQUIPMENT OPTIONS

Each kids outdoor gym unit can accommodate 6 individual workout stations, and we offer 12 different types of machines - this includes 4 machines that are wheelchair accessible.

---

**SPEAK TO OUR TEAM TO DISCUSS YOUR SPECIFIC REQUIREMENTS AND WE WILL BE HAPPY TO ADVISE ON THE BEST MIX OF EQUIPMENT FOR YOU!**

---

# Our Equipment

Our equipment has been designed to be fully interchangeable. That means you can select any 6 pieces from our range to build your very own totally bespoke kids outdoor gym!

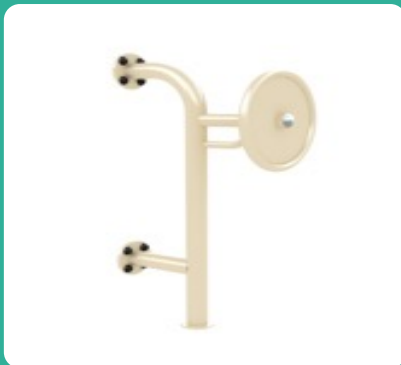

**SHOULDER FLEX**

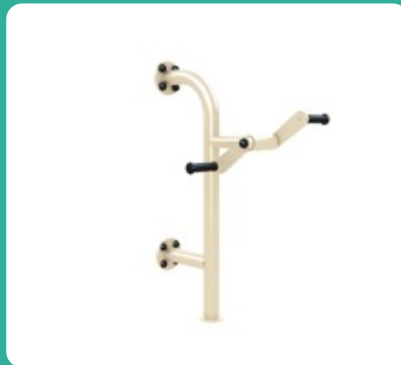

**HAND CYCLE**



**DIP BARS**



**PULL DOWN**

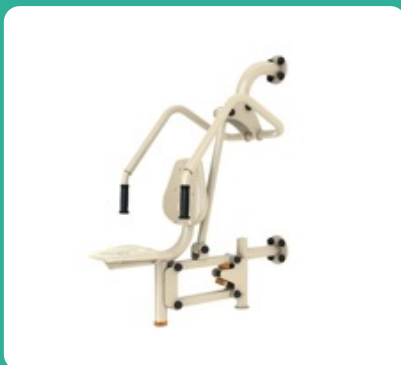

**CHEST PRESS**



**LEG PRESS**

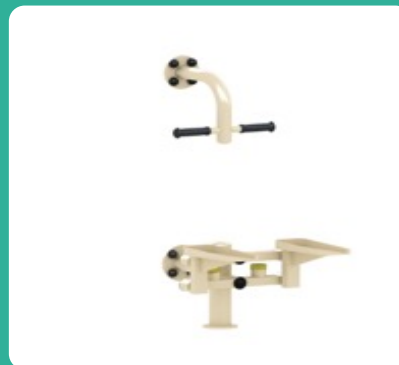

**STEPPER**

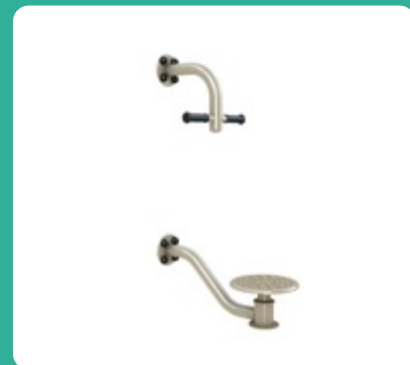

**ROTATOR**



**BIKE**



**CROSTRAINER**

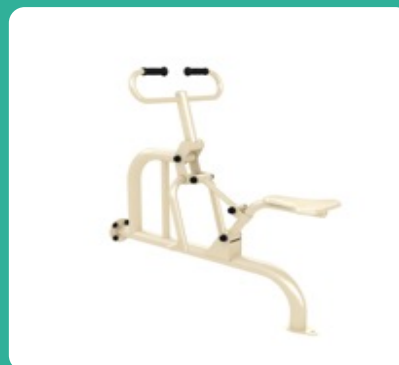

**RIDER**

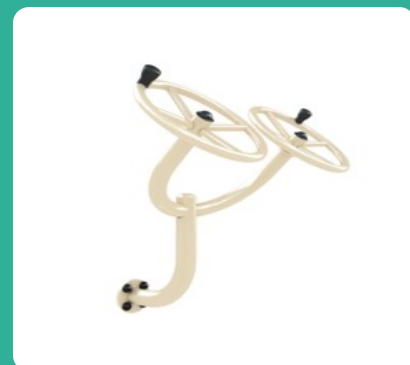

**SHOULDER EXTENSION**

# MAKING KIDS OUTDOOR GYM EQUIPMENT A SMART INVESTMENT



## SAFETY FIRST

Safety is paramount when it comes to children's well-being. Our kids outdoor gym equipment is designed with meticulous attention to detail, and has been independently assessed by RoSPA (Royal Society for the Prevention of Accidents).

Each piece of equipment undergoes rigorous testing to ensure durability, stability, and child-friendly features. Our equipment is crafted from high-quality materials, with rounded edges, non-slip surfaces, and robust constructions, offering maximum safety for young users.



## DURABILITY AND LOW MAINTENANCE

We know the importance of long-lasting equipment that can withstand the rigours of daily use, and the Irish elements. Our kids outdoor gym equipment is built to last, with heavy gauge steel, galvanised and powder coated to provide maximum resistance to the Irish elements. They are essentially vandal proof and require minimal maintenance and upkeep.



## SIMPLE TO INSTALL

Our range of kids outdoor gym equipment is unique in that it does not require any site preparation or groundworks. Our team simply arrive with the equipment, set it up wherever you want, and are finished within the day, leaving you with your kids outdoor gym ready for use in your next PE class!

# SPECIFICATIONS AND TECHNICAL DATA

All kids fitness equipment from OUTFIT is manufactured and assembled to comply with highest design and specifications criteria. All individual outdoor fitness machine designs have been inspected by the relevant Standards Authority and are TUV certified. The standards applied are recognised worldwide. All the fitness stations have been inspected and approved by RoSPA. Our manufacturing facility has also acquired ISO9001 certification for production, together with many other awards.



# SITE SELECTION AND PREPARATION

OUTFIT Kids gym equipment comes with its own integrated anti-slip base and is designed to be suitable for installation on the widest range of surfaces including grass, concrete, tarmacadam, astroturf, rubber matting etc., both indoor and outdoor.

In order to facilitate the optimal installation of the machines follow these basic recommendations:

- ▲ Allow a minimum area of 4m x 4m with unhindered access per set.
- ▲ Ensure the selected area is level in all directions, and ground is solid.
- ▲ Ensure there are no drains/cables/water mains/sewers etc in the vicinity of the installation.
- ▲ Avoid locations underneath power lines, large trees or other potentially hazardous structures.
- ▲ Consider access, monitoring, lighting, security, disabled access, etc.

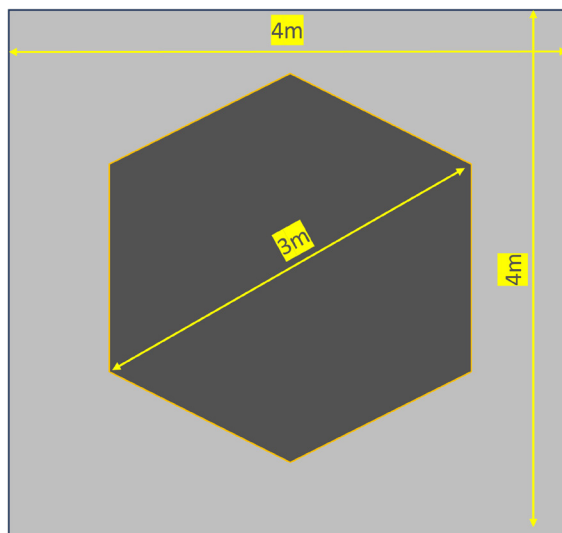



# ABOUT OUTFIT

OUTFIT have been providing Outdoor Gyms and Fitness Equipment across the island of Ireland for over 15 years. We work with local councils, community groups, schools, sports clubs, healthcare facilities, educational facilities, private companies, and anyone else who may want to have their very own outdoor fitness area!

Our team possesses the greatest amount of experience and expertise of anyone in the industry in Ireland, having installed over 350 outdoor fitness areas since 2008. With over 15 years of direct industry experience, 30 years of experience in civil works and construction, and with equipment designed by our in-house qualified fitness professionals – we are the outdoor fitness experts.



## CERTIFICATION & AWARDS

Our equipment is certified to and complies with the highest EU and international standards. Beware of false imitations - equipment which can look the same but be built very differently. Always ask for spec sheets and make sure you are purchasing equipment which can withstand our Irish weather.



## OUR COMMITMENT TO YOU

**OUTFIT will be available at all times to assist you or your outdoor gym user in every way. We pride ourselves on our relationships with our customers which we have built over 15 years in the industry. We are a family business, and our reputation and relationships are very important to us. Our customers experience this and know they can rely on us and trust us to give them the best possible service, every time.**



## **INVEST IN THE FUTURE**

Investing in kids outdoor gym equipment is an investment in the future health and well-being of the kids in your care. By providing an engaging and interactive fitness experience, you'll be empowering children to develop healthy habits that can last a lifetime. Not only will you be encouraging physical activity, but you will also cultivate important life skills such as teamwork, perseverance, and self-confidence.

---

Contact us today to learn more about how our kids outdoor gym equipment can transform your school or facility into a hub of active play and healthy habits. Give your children the gift of fitness, setting them on a path to a brighter and healthier future!

---

# ADDITIONAL INFORMATION

## STRUCTURE AND MANAGEMENT

Irish owned and incorporated private limited company based in County Mayo, trading as OUTFIT.

VAT registered; RCT registered; fully tax compliant; full comprehensive insurance; TUV certified, CE certified, RoSPA membership; F.I.T. membership.

## HEALTH & SAFETY

All OUTFIT installations and siteworks are carried out in compliance with the “*Safety, Health and Welfare at Work Act, 2005*” together with the “*Construction Regulations Act, 2006*” and all other relevant acts. Independent post-installation inspection/certification carried out by RoSPA/PSI can be arranged for all installations.

## INSURANCE

Fully comprehensive insurance; Employer’s liability - €13m; Public liability - €6.5m; Products liability - €6.5m; Sub-contractor’s waiver; Professional Indemnity - €2m; Indemnity to Principals - €2m.

No claims to date or pending.

## AVAILABLE ON REQUEST

- ▲ Comprehensive, up-to-date Health and Safety Statement.
- ▲ Current insurance policy & tax clearance certificate.
- ▲ No-obligation site visit and/or quotation.
- ▲ Method statement and risk assessment statements.
- ▲ List of recent installations and references
- ▲ Bank References.

# OUTFIT Junior

**CONTACT US**



James Street,  
Kiltimagh,  
Co Mayo



+353 94 938 1088  
+353 86 190 2606



info@outfit.ie  
www.outfit.ie